























- | | |
|---|--|
| <p>1.  7.5 A Parklys, VF, HB, skiltbelysning, digitalt klokke motorromsbelysning</p> <p>2.  7.5 A Parklys-HF, VB, skiltbelysning instrumentbelysn. via reostat. Lys i sigarettenner og askebeger. Kontrollampe parklys.</p> <p>3.  10 A Nærlys venstre side. Kontrollampe for nærlys.</p> <p>4.  10 A Nærlys høyre side.</p> <p>5.  10 A Fjernlys venstre side. Kontrollampe for fjernlys.</p> <p>6.  10 A Fjernlys høyre side.</p> <p>7.  15 A Tåkelys og kontrollampe for tåkelys.</p> <p>8.  7.5 A Tåkebaklys og kontrollampe for tåkebaklys.</p> <p>9.  20 A Elektrisk oppvarmet bakrute og kontrollampe for denne.</p> <p>10.  20 A Horn</p> <p>11.  25 A Kjølevifte for motor</p> <p>12.  10 A Sigarettenner foran og radio.</p> <p>13.  10 A Digitalt klokke, varselblinklys. Innvendig belysn. i bilen. Hanskeromsbelysn. Bagasjeromsbelysn.</p> | <p>14.  20 A Sentraldørlås. (styresentrale)</p> <p>15. STOP 7.5 A Bremselys</p> <p>16.  7.5 A Checkpanel, digitalt klokke (tenning på) Elektrisk speil</p> <p>17.  20 A Blinklys, ryggelys, automatisk</p> <p>18.  25 A Varmeapparatsvifte</p> <p>19.  25 A Elektriske vindusheisere foran høyre side</p> <p>20.  25 A Elektriske vindusheisere bak og elektrisk soltak</p> <p>21.  15 A Elektrisk oppvarmet sete</p> <p>22.  10 A Elektrisk bensinpumpe</p> <p>23.  10 A Sigarettenner bak</p> <p>24.  15 A Elektriske vindusheiser foran venstre side</p> |
|---|--|

RELEER

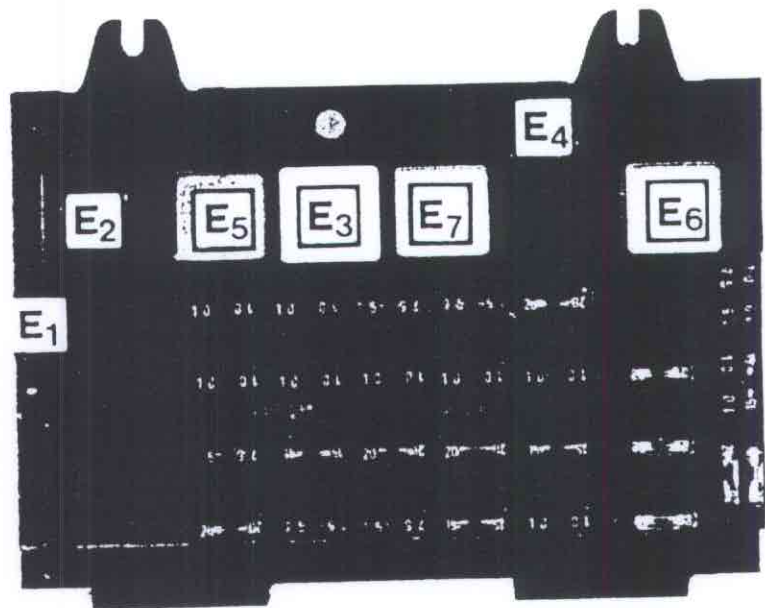

Reléene og sikringene sitter under dashbordet på venstre side.

E1 = Ledig

E2 = Blinklysrelé

E3 = Startsperrerele på biler med automatisk gearkasse

E4 = Tåkelys foran

E5 = Hornrelé

E6 = Elektrisk oppvarmet bakrute

E7 = Tenningsrelé (15)

Sentraldørlåsrelé under hanskerommets venstre side.

Kjørelysrelé sitter sammen med timerrelé (rød sokkel) i tenningslås

Timerrelé for ~~interior~~ belysning sitter under dashbordet på høyre side.

Elektroniske rele for LE2 Jetronic, sitter bak batteriet.

Relé for tomgangsolenoid "1 Bosch LE-2 Jetronic med A.P. automatisk gearkasse sitter på innerskjermen ved batteriet.

Relé for vinduspusset bak sitter bak på v. side ved spyletanken.

Reléene for el. selte regulering sitter foran bryterene under plast dekslet.

På automat rele for kjølerifte

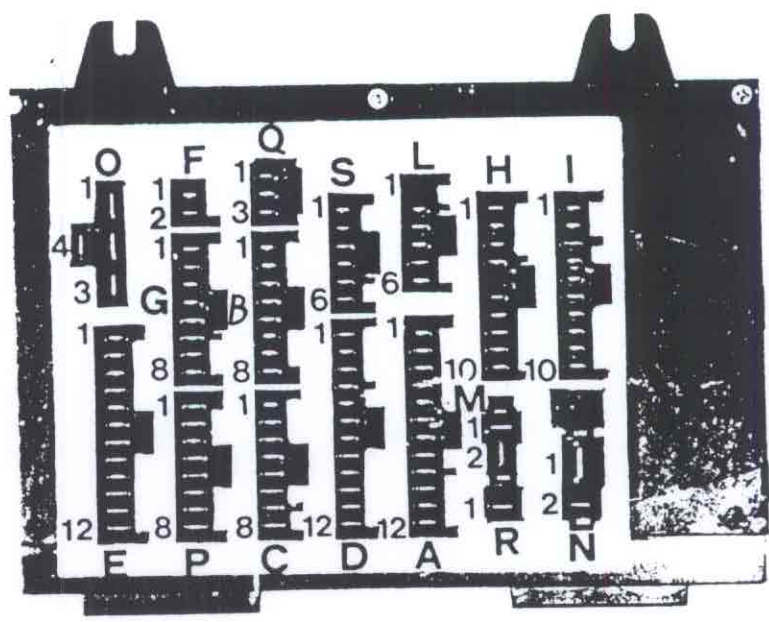

Gjelder tema:

	1	2	3	4	5	6	7	8	9	10	11	12
A	G	AB	GN	SN	MB	RN	GV	AN	GR	HR	RV	
B	MB	NZ	AG	AB	AN	—	M	HN				
C	HN	GN/GN	B	VN	GR	C	AB/AB	R				
D	HG	S	G	H	MB	RN	GR	GN	R	HR	RV	SN
E	GN/GN	N/N	—	GR	A	RN	BN	S/SN	V	GV	MB	R
F	VN	RN										
G	H	B	V	BN	G	M/M	AB	AN				
H	GR	—	H	Z	—	AB	BR	BN	B	AG		
I	GR	GN	V	H	AB	AN	MB	M	HN	VN		
L	—	MB	AG	R	H	SN						
M	AS	—										
N	N	—										
O	S	—	VN	LR								
P	AN	AB/AB	MB	AG	CB	BN	VB	HR/HR				
Q	—	—	—									
R	N											
S	B	G	HR	V	RN	R						

SENTRALDØRLÅS CROMA

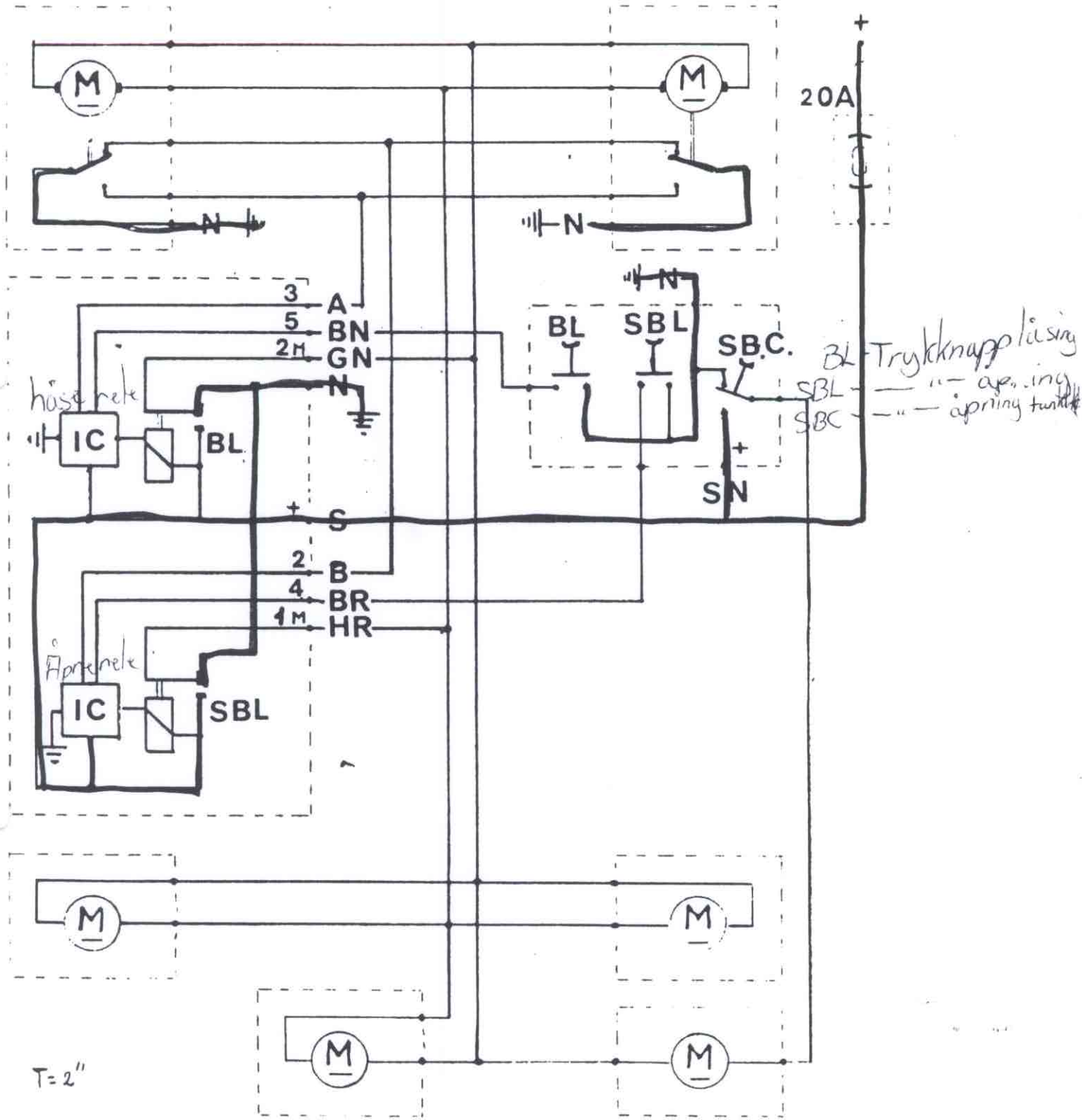

CROMA

Starter - tenningsanlegg DIGIPLEX - ladeanlegg - bensinkutt - varsellampe for lavt bremsevæsknivå - håndbremslampe

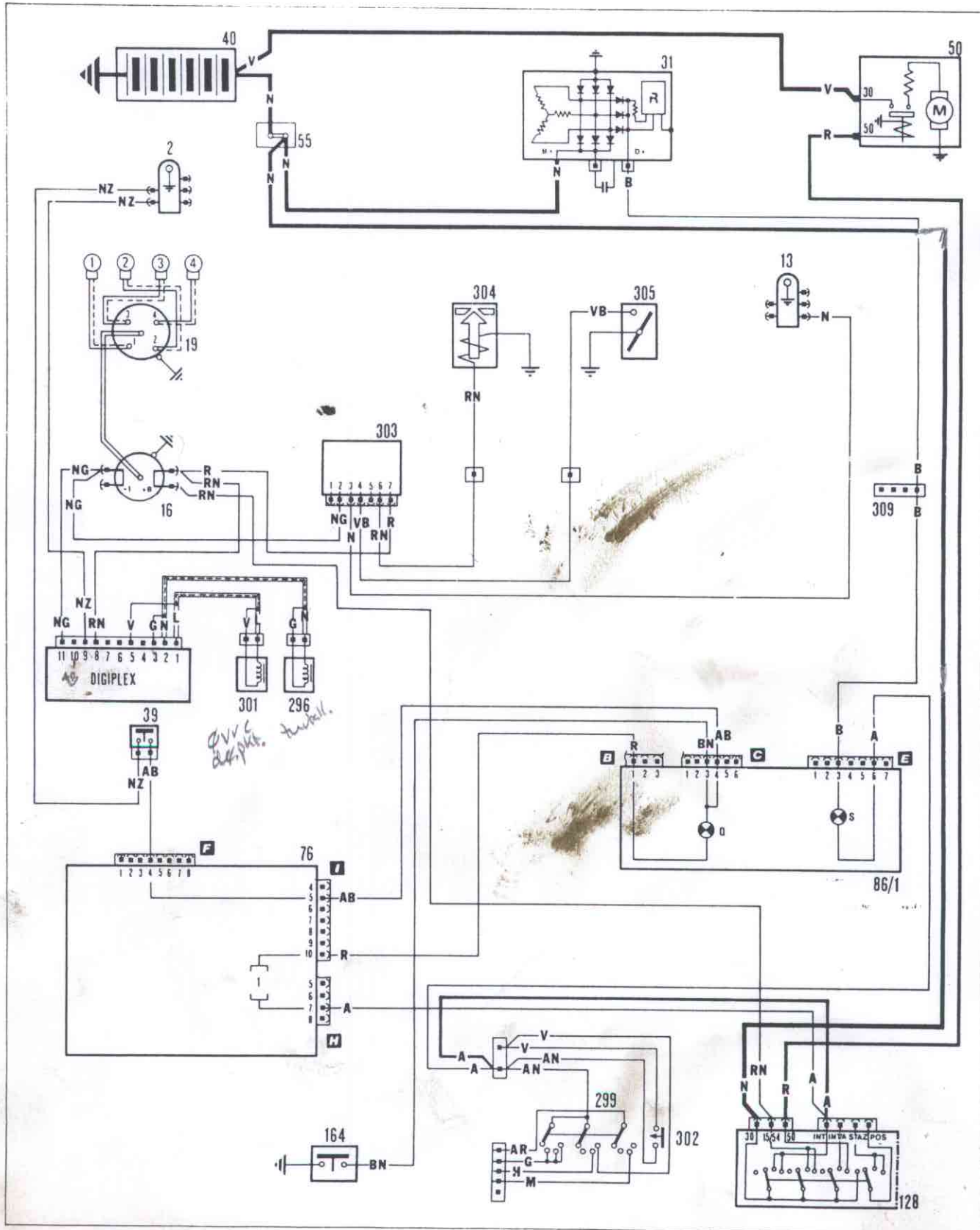

CROMA - CROMA CHT - CROMA D

Skiltlys - parklys med kontrollampe - nærlys - fjernlys med kontrollampe - blinklys - nødblinklys - instrumentbelysning

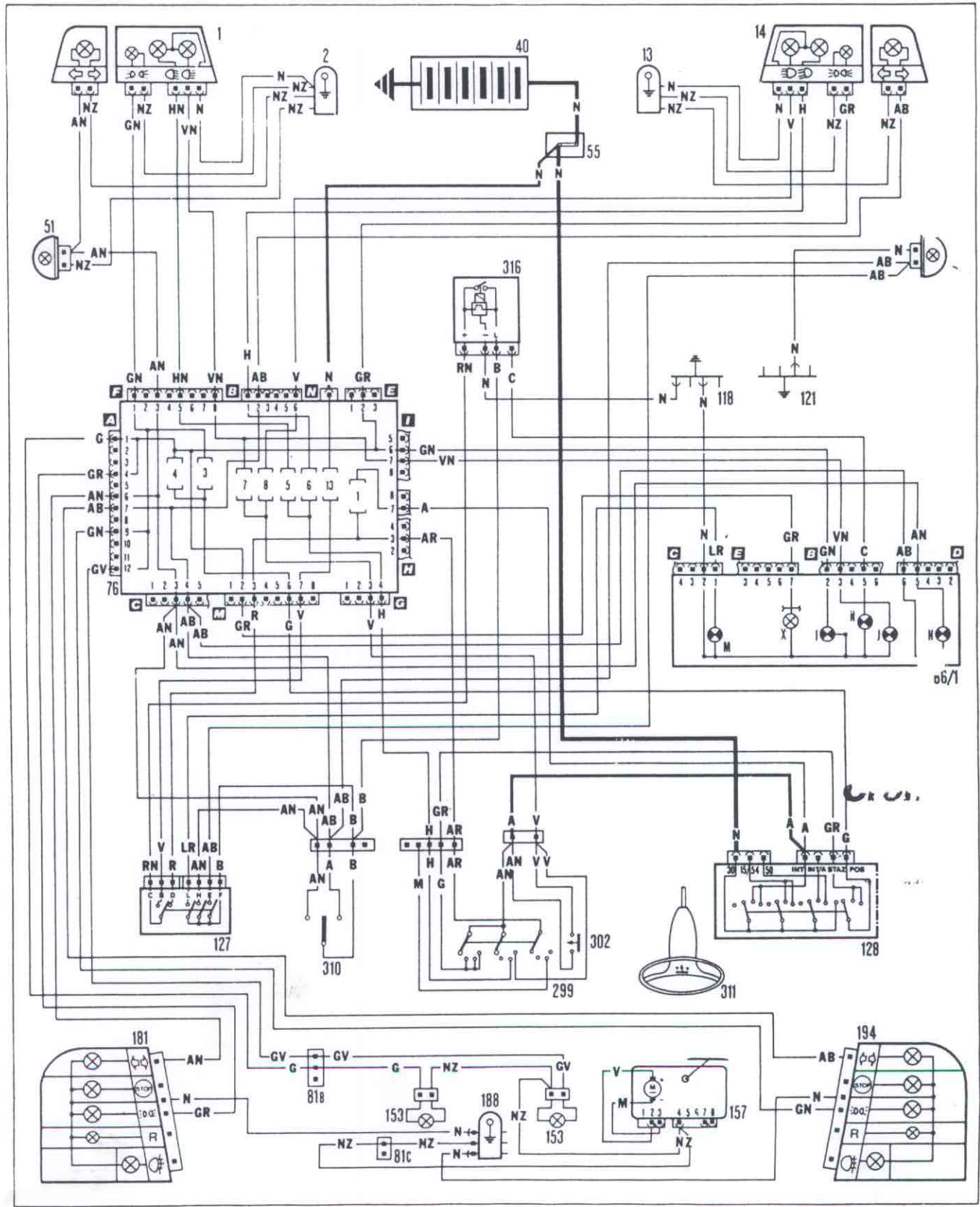

CROMA - CROMA CHT - CROMA D

El. oppvarmet bakrute med kontrollampe - tåkebaklys med kontrollampe -
 ryggelys - bremselys - belysning varmeapparatets betjeningshendler -
 symbolbelysning - analogklokke - sensor for slitte bremsesklosser med
 varsellampe

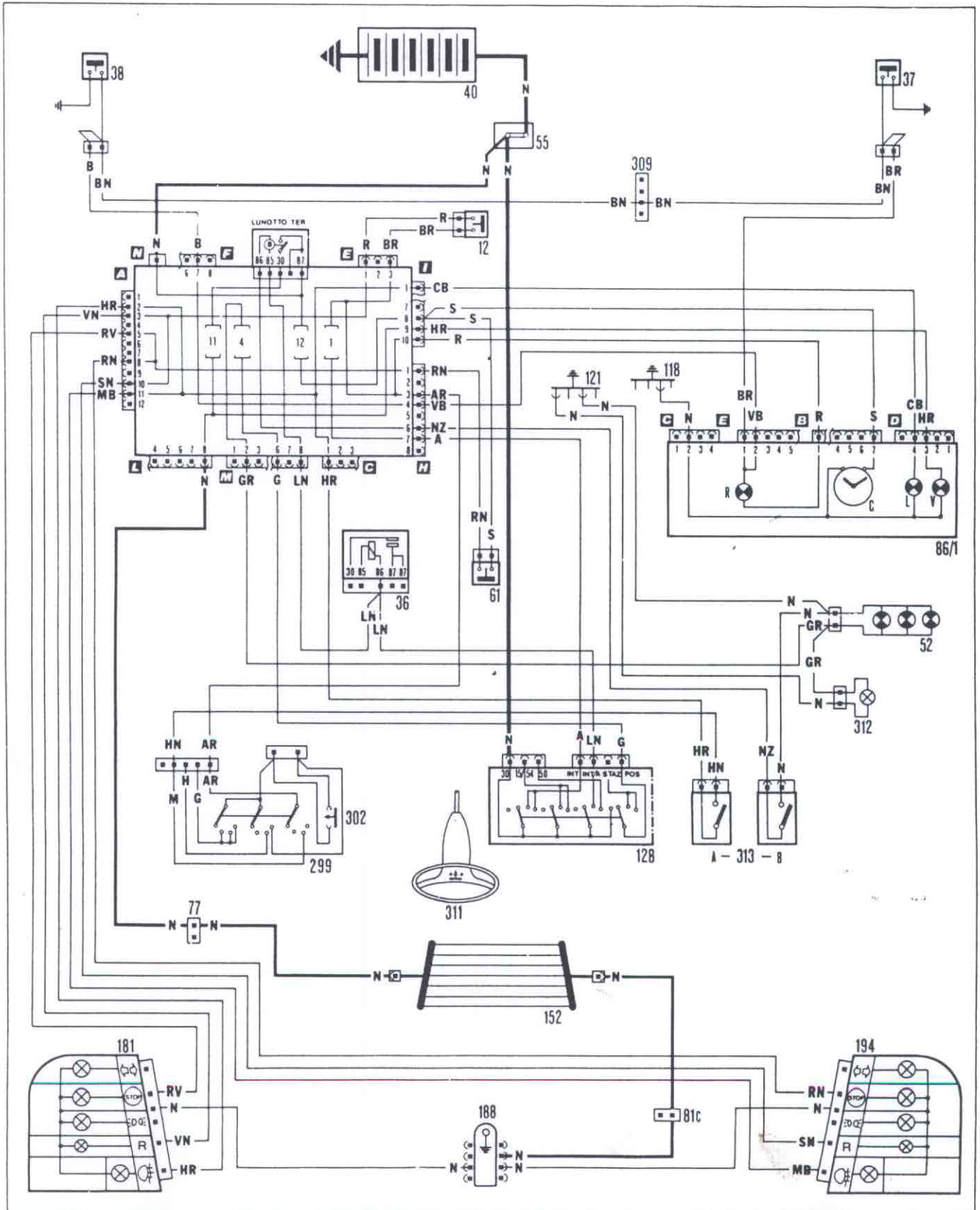

CROMA - CROMA CHT - CROMA D

Innvendig belysning - hanskeromsbelysning - bagasjeromsbelysning - sigaretttenner

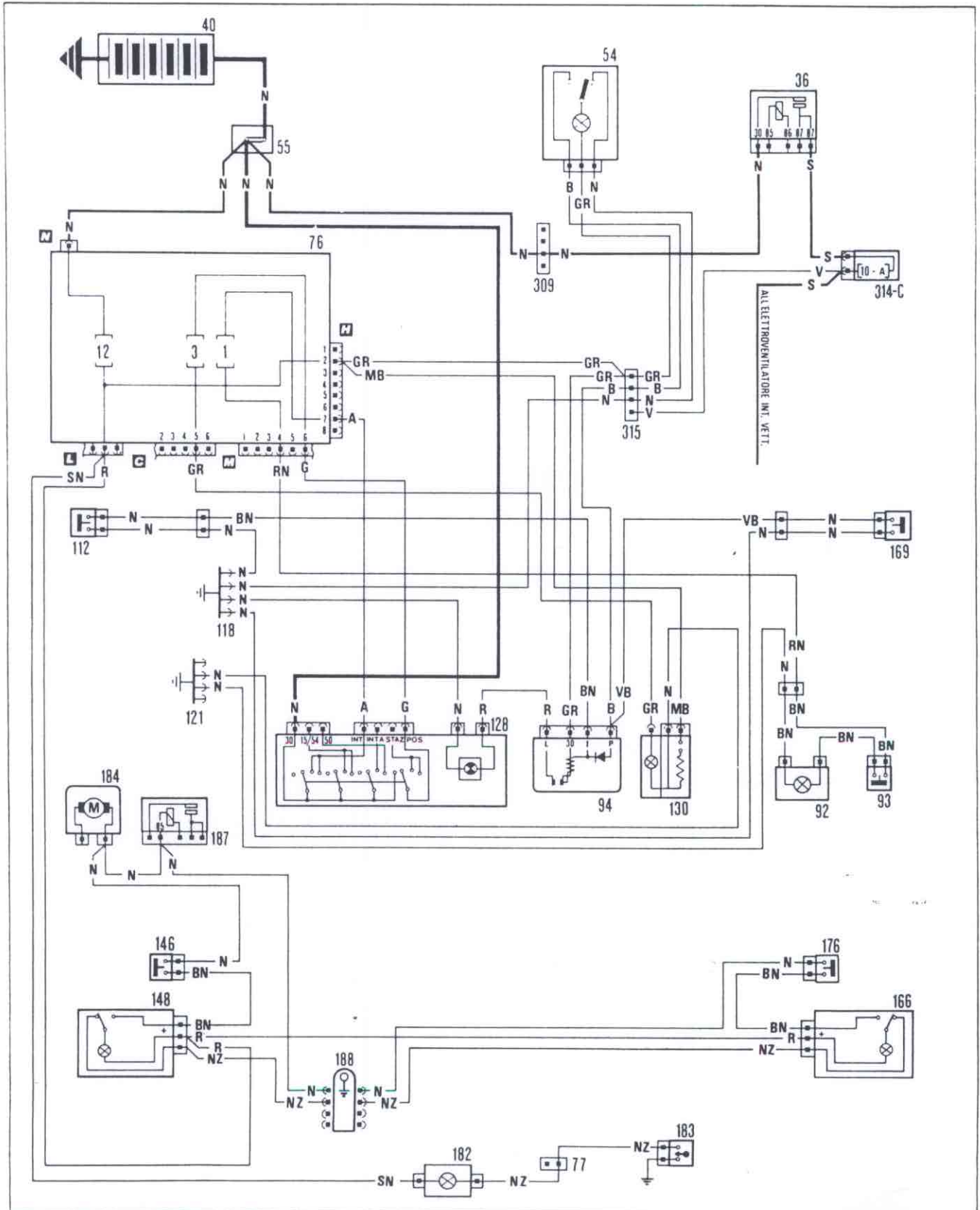

CROMA - CROMA CHT - CROMA D

Varme/ventilasjon - horn - oljetrykkslampe motor - temp.måler for motor med kontrollampe for høy motortemp. - kjølevifte radiator - bensinmåler med varsellampe for bensinreserve

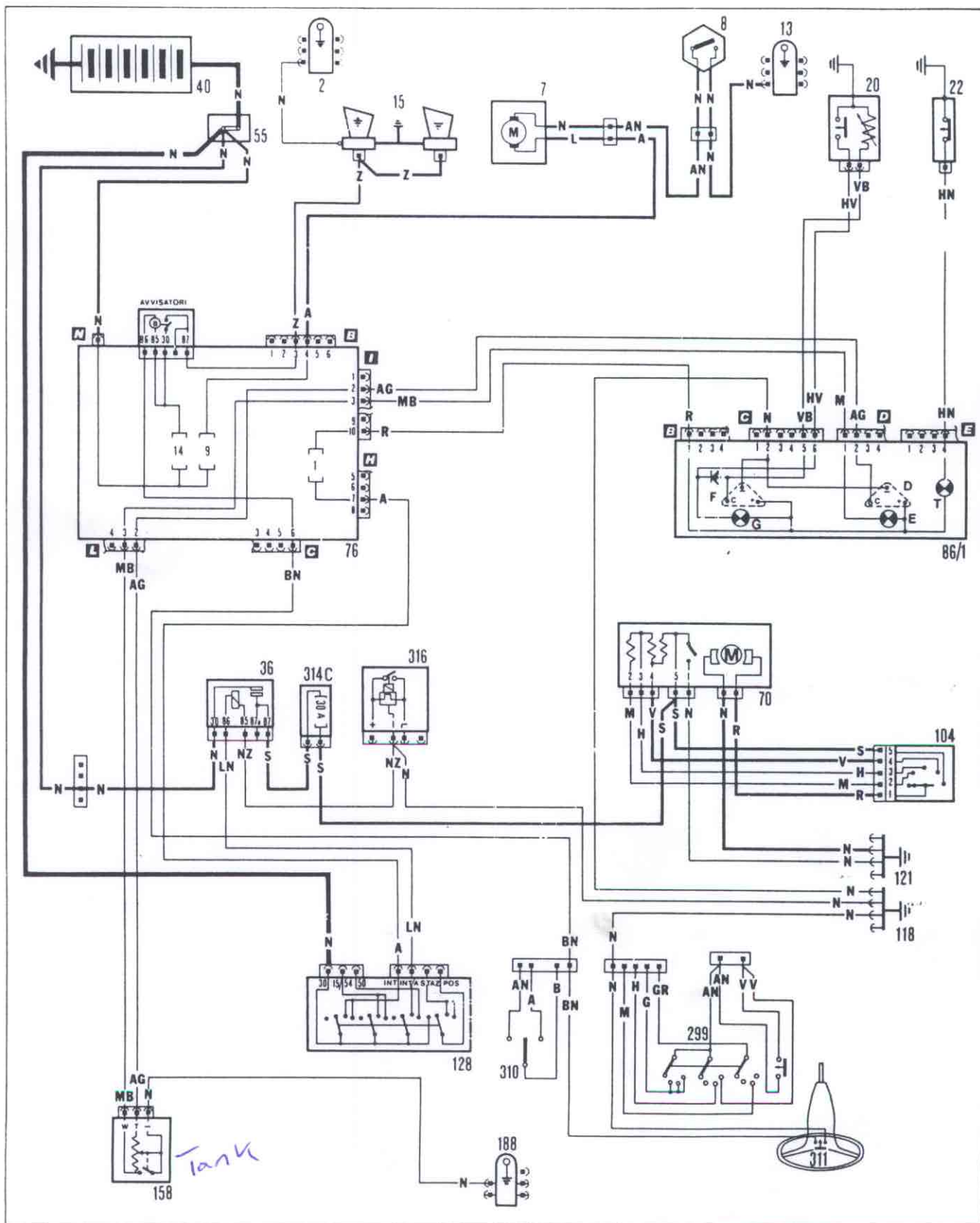

CROMA - CROMA CHT - CROMA D

El. betjente vinduer foran - sentraldørlås

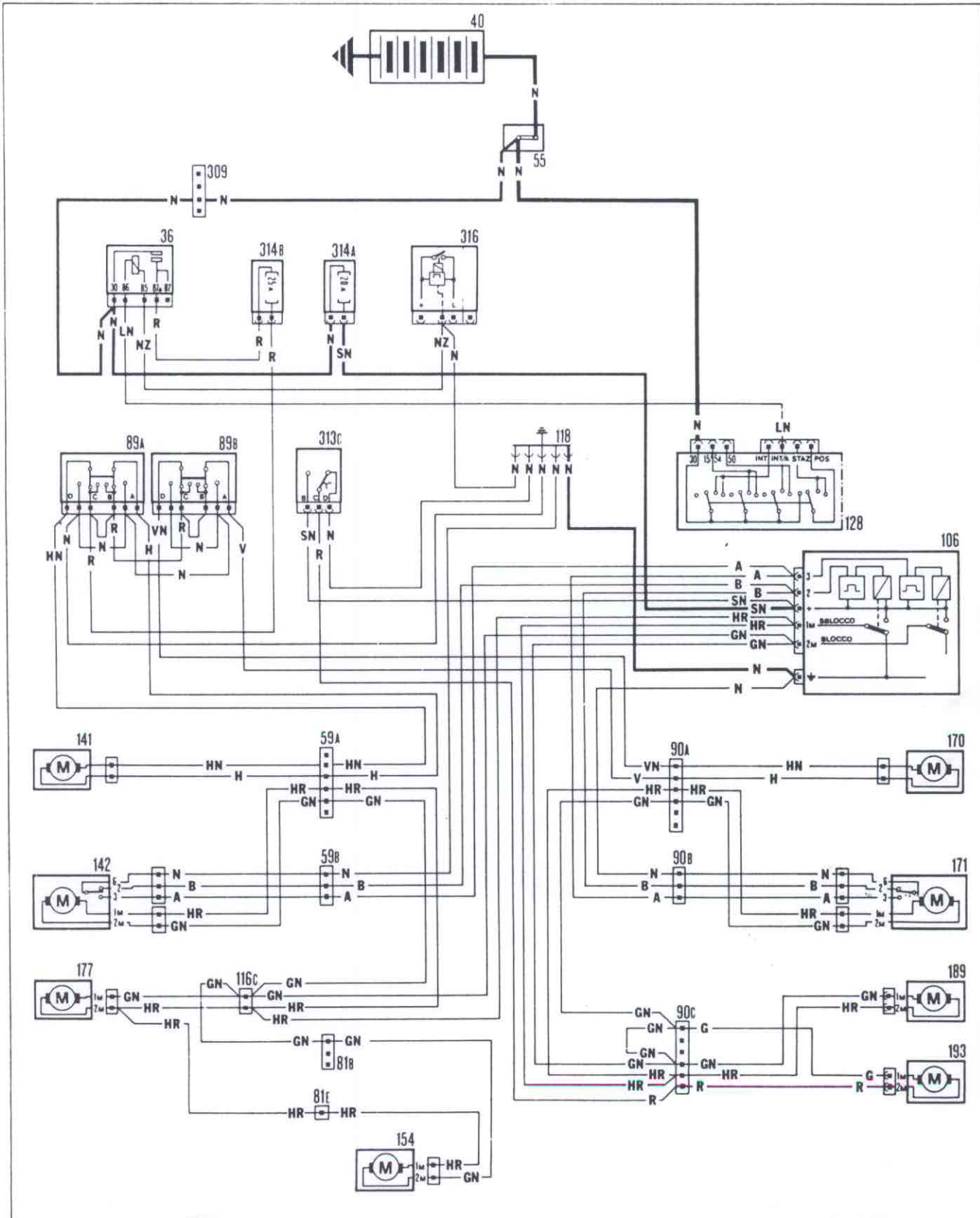

CROMA - CROMA CHT - CROMA D

Vinduspusser - vindusspyler - radiotilkobling med høytalere - vinduspusser og spyler bak

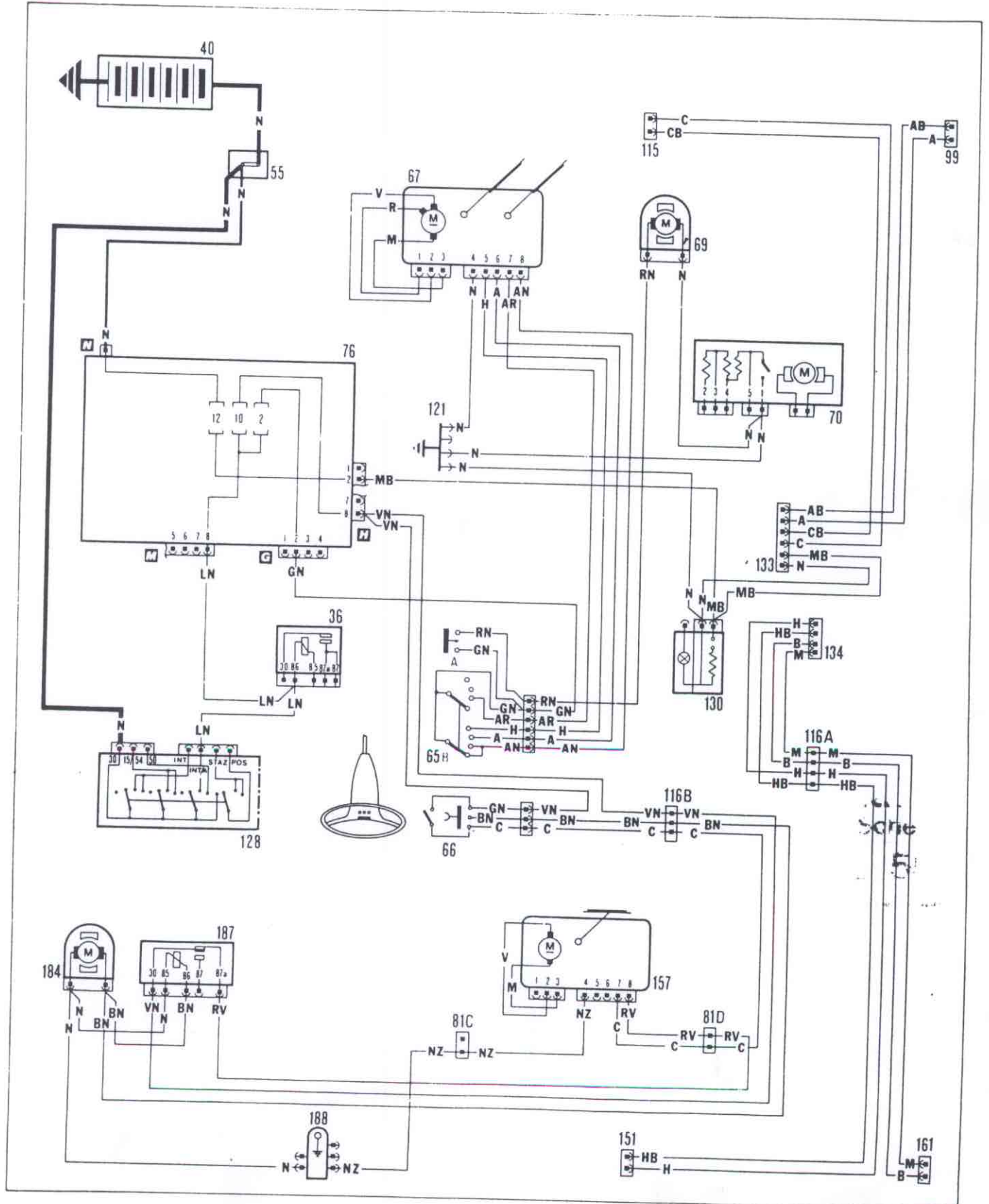

CROMA CHT

Starter - Marelli stiftløs tenningsanlegg - ladeanlegg - bensinkutt - termostater og solenoidventil for vakuumpregulering til foredeleren

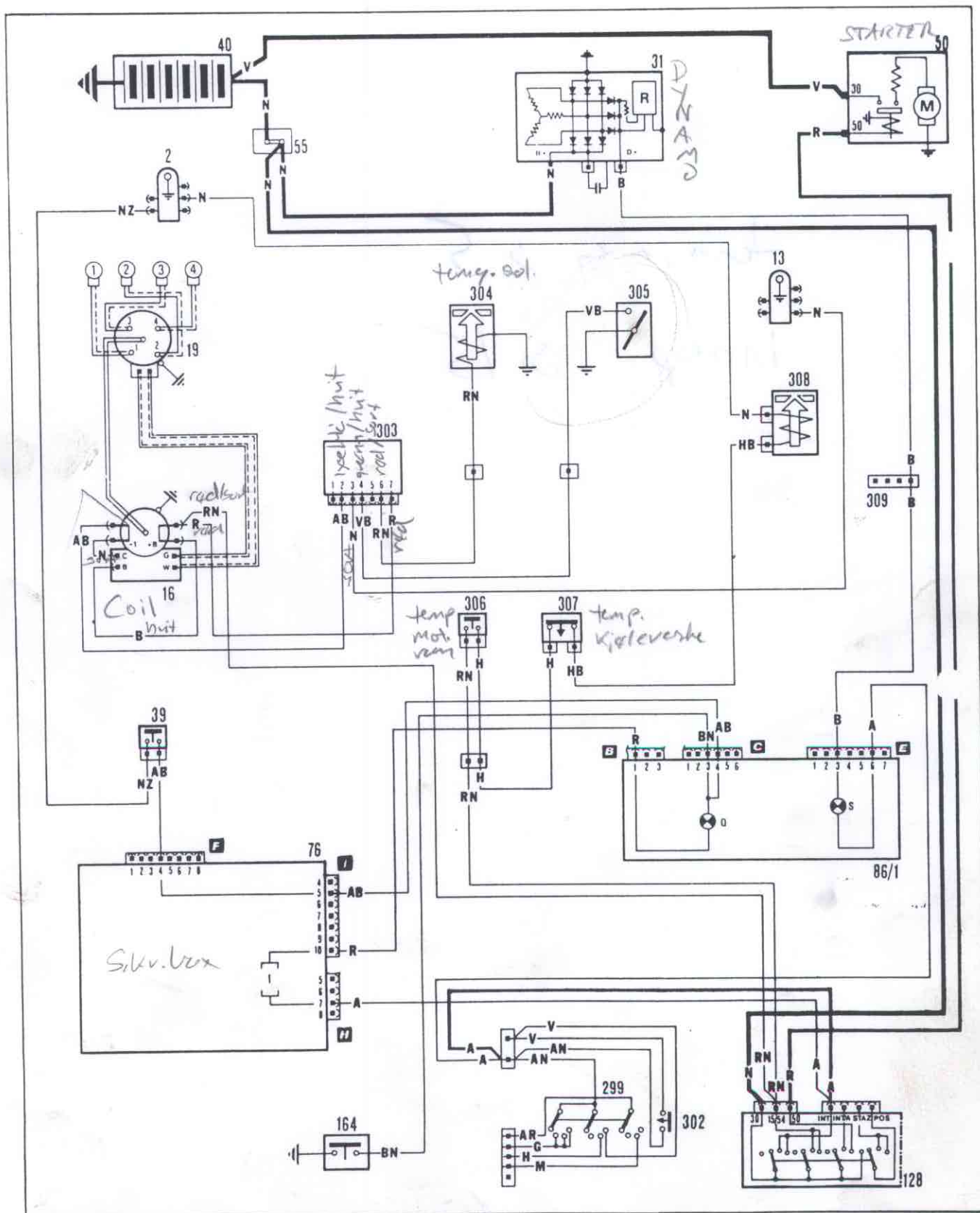

CROMA D

Starter - ladeanlegg - glødeanlegget - oljetrykksmåler

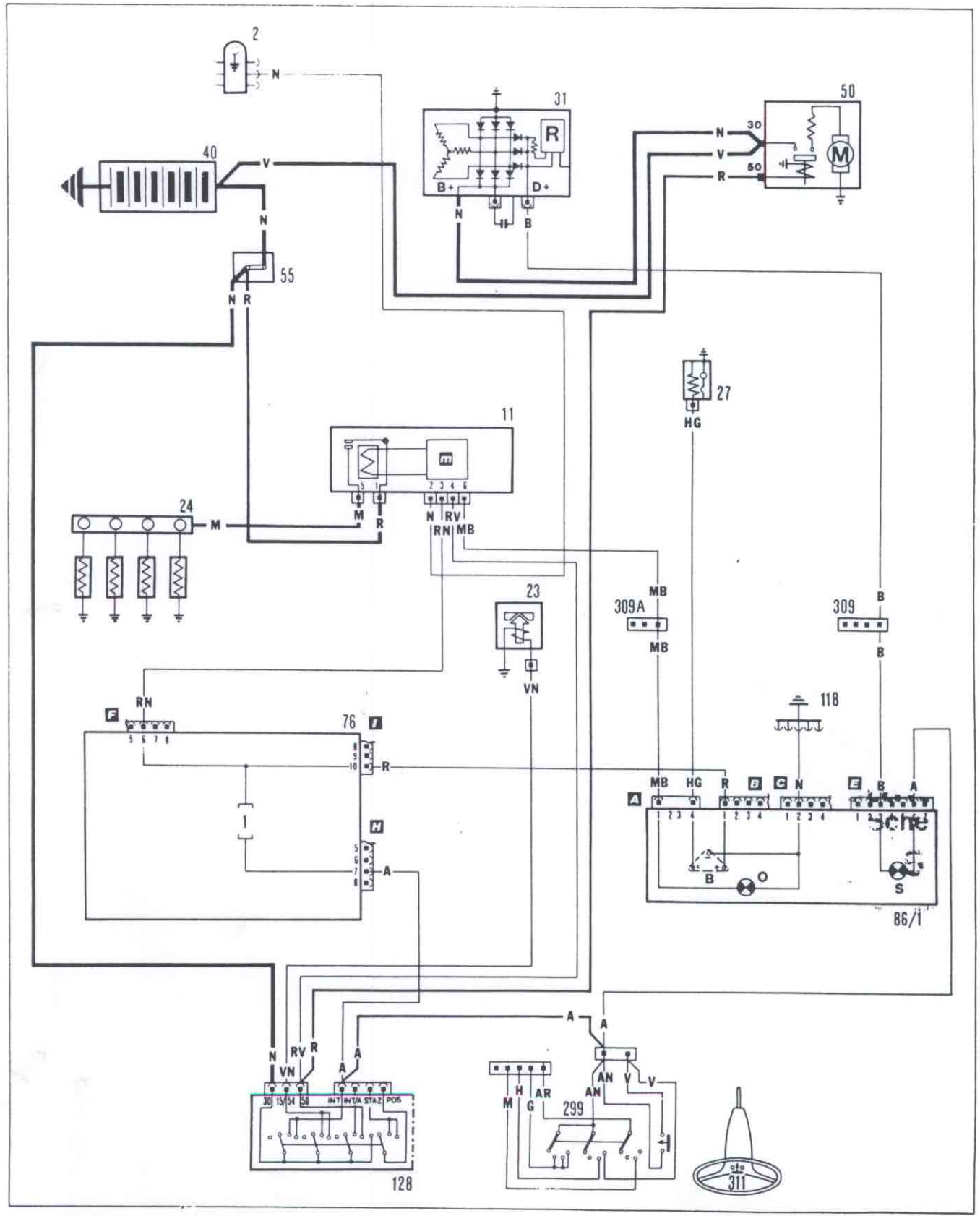

CROMA CHT

Starter - ladeanlegg - Marelli stiftløst tenningsanlegg - bensinkutt - termostater og solenoidventil for vakuumberegning til fordeleren

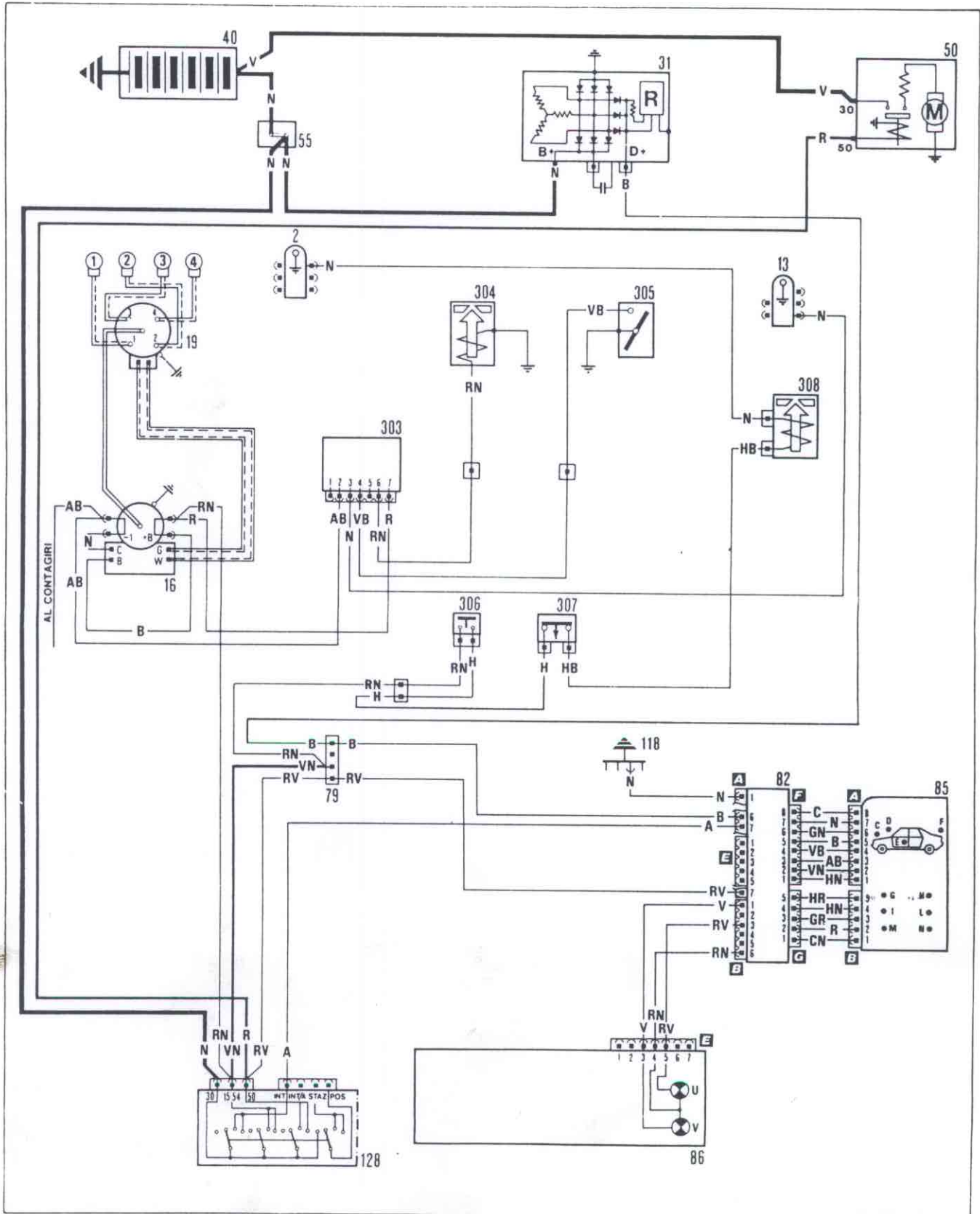

CROMA I.E.

Starter - tenning og innsprøyting WEBER I.A.W. - el. bensinpumpe

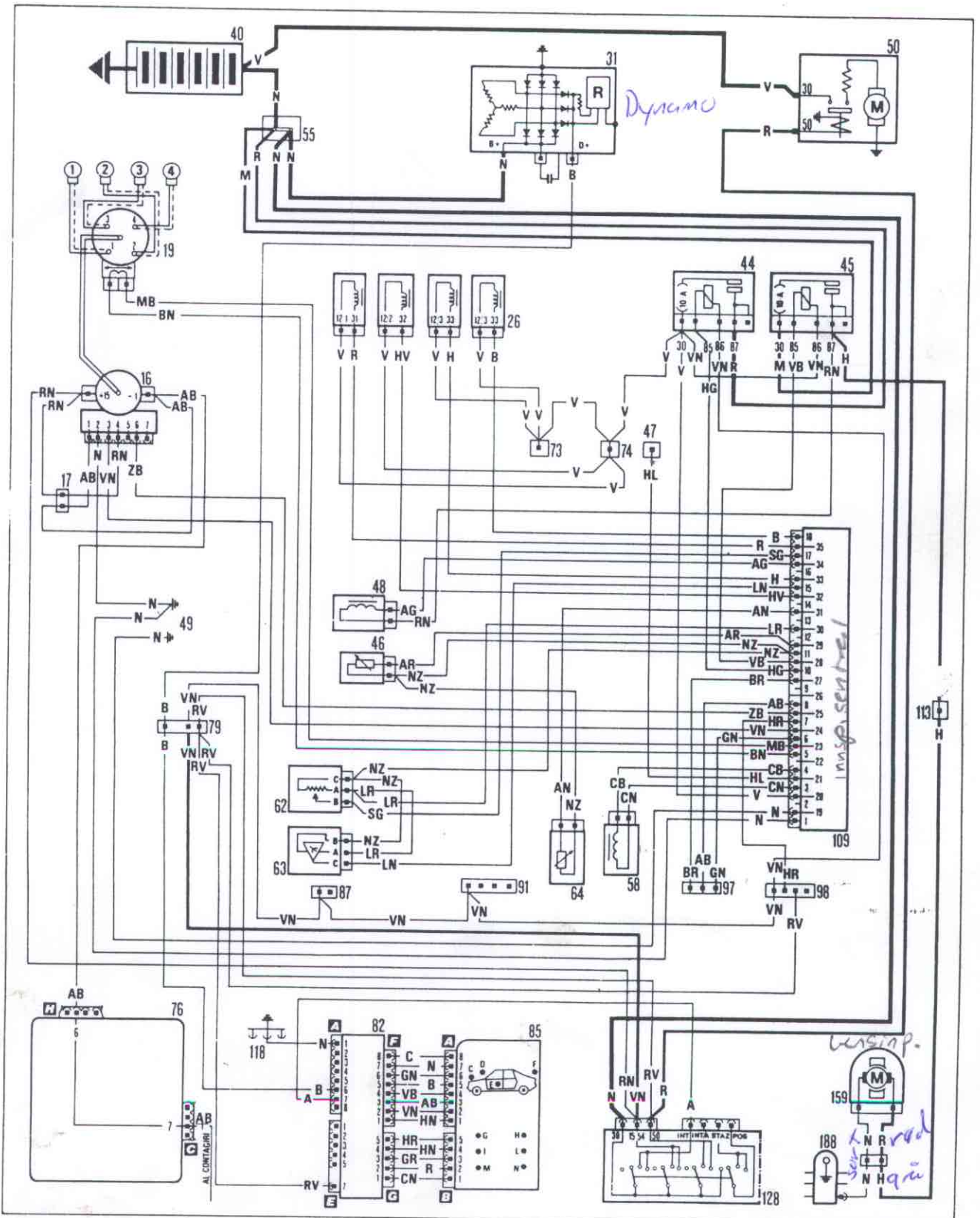

CROMA CHT - CROMA I.E. - CROMA TURBO I.E. - CROMA TURBO D

Parklys med kontrollampe - nærllys - fjernlys med kontrollampe - skiltlys - blinklys - reostat for instrumentbelysning - nødblinklys

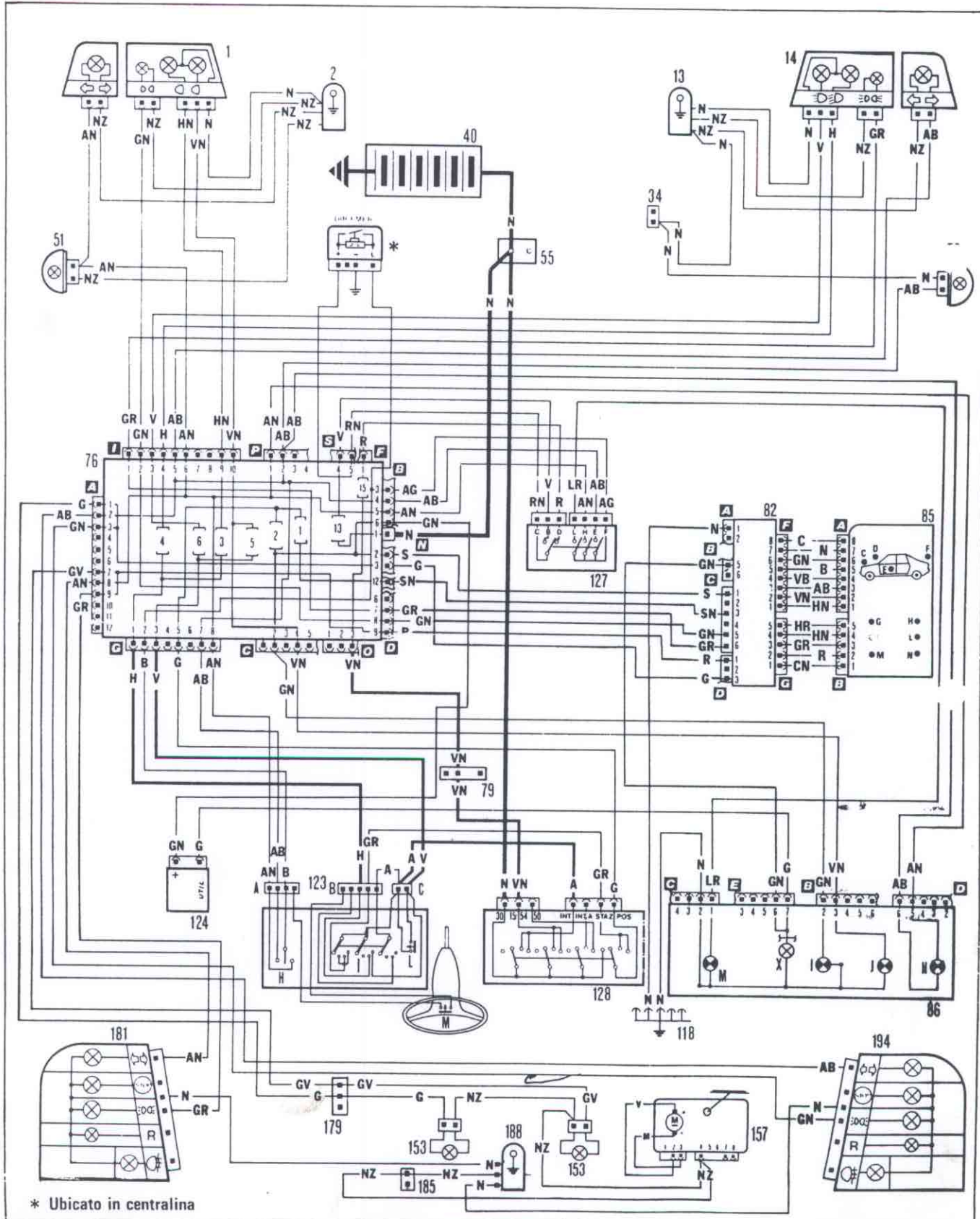

CROMA CHT - CROMA I.E. - CROMA TURBO I.E. - CROMA TURBO D

El.oppvarmet bakrute med kontrollampe - tilkobling for tåkelys -
 tåkebaklys med kontrollampe - ryggelys - bremselys

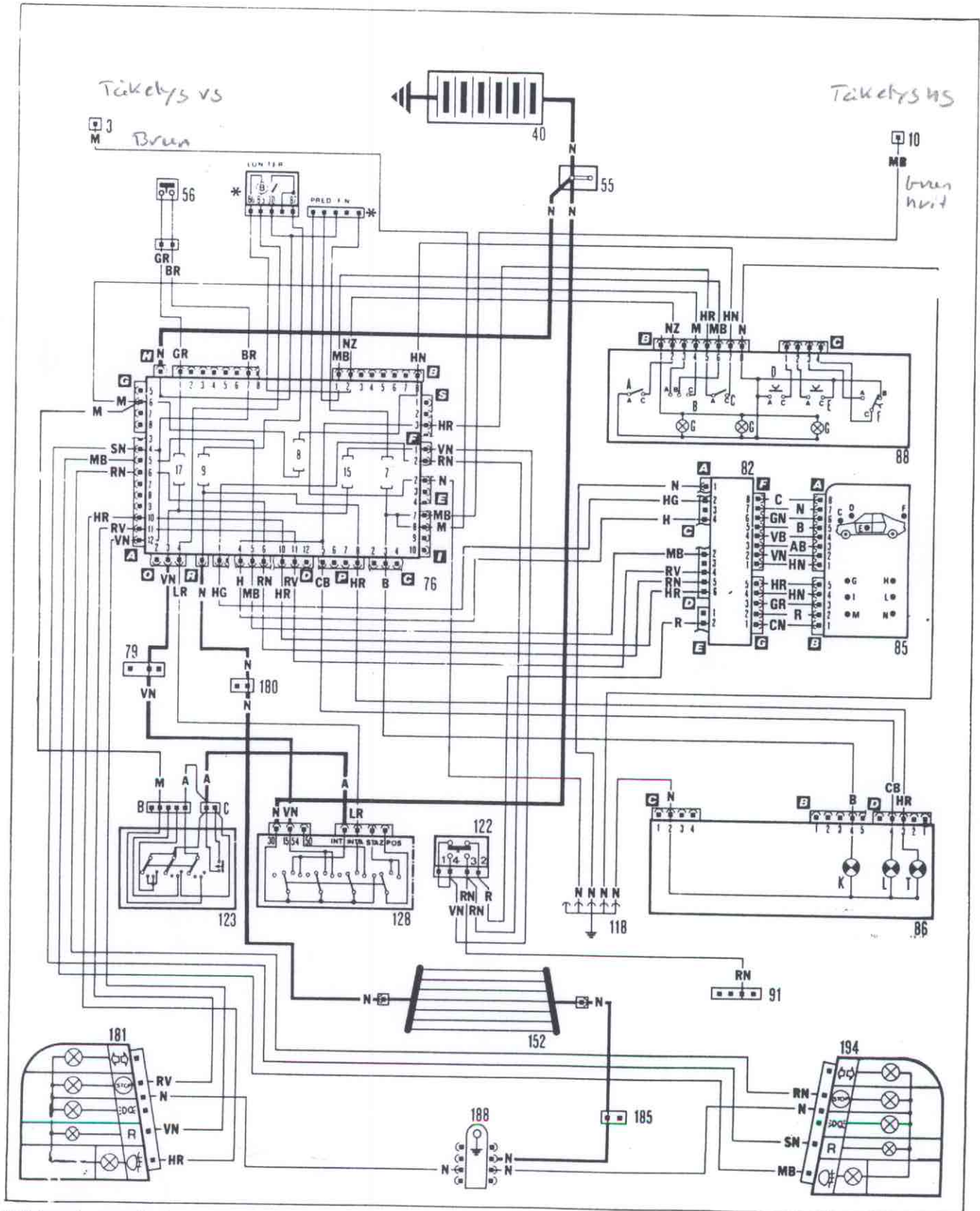

(*Ubicato in centralina)

CROMA CHT - CROMA I.E. - CROMA TURBO I.E. - CROMA TURBO D

Innvendig belysning - hanskeromsbelysning - bagasjeromsbelysning - sigarettenner - digitalklokke - checkpanel dørslukking

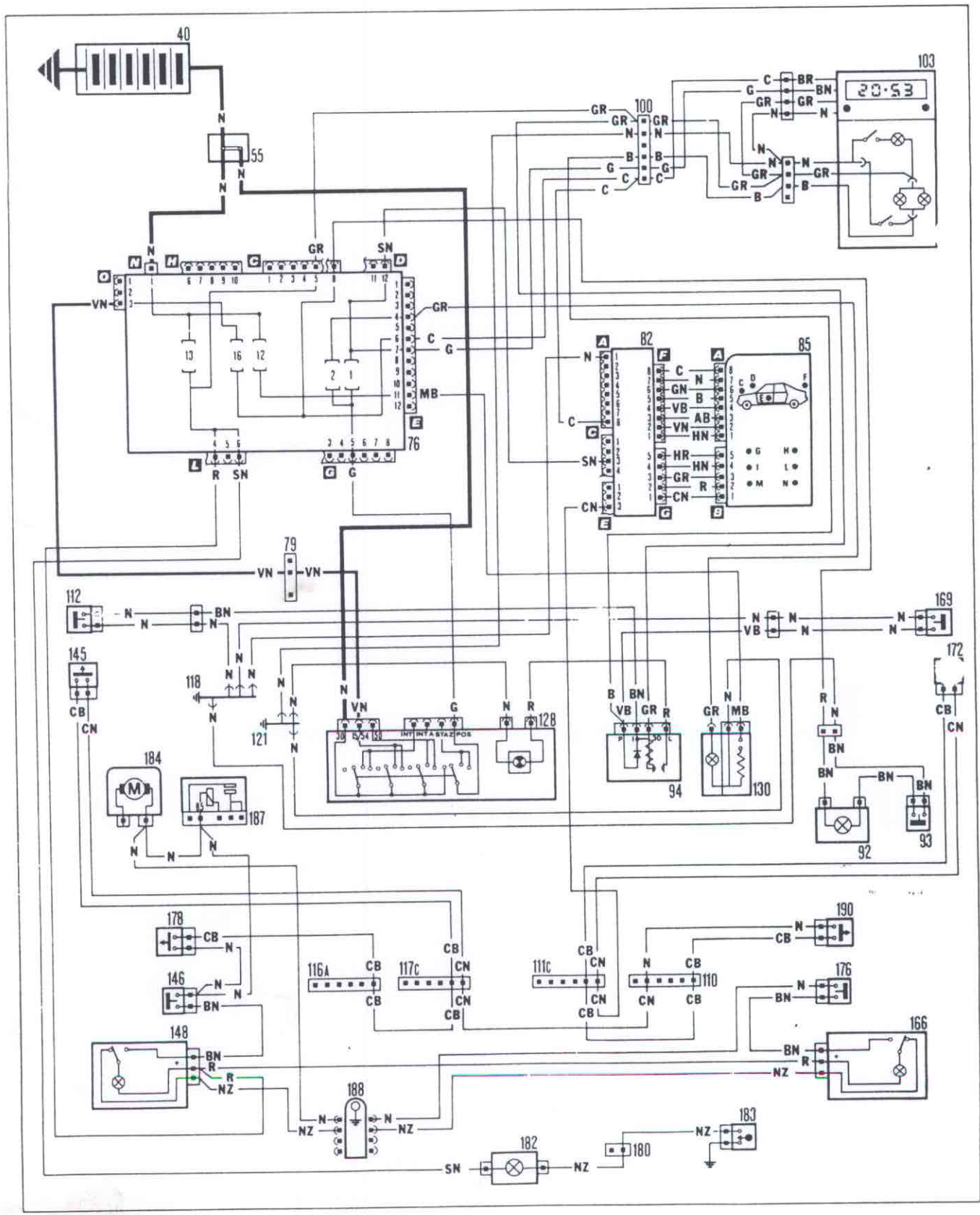

CROMA CHT - CROMA I.E. - CROMA TURBO I.E. - CROMA TURBO D
El.betjente vinduer foran og bak - sentraldørlås

